

INSTALLATION INSTRUCTIONS FOR MODEL LFF-06:

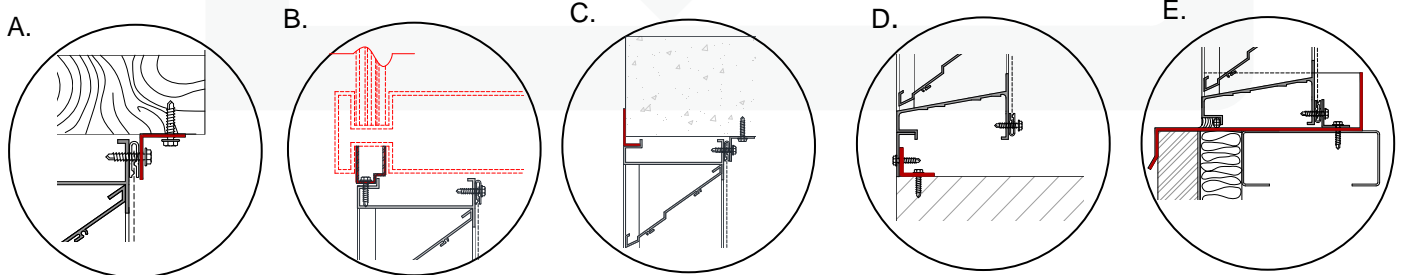

- No installation shall be made without first reading these instructions.
- Installation shall be made in accordance with Dowco's shop drawings or as per recommended instructions stated herein. (Do not commence installation if products are defective or if damage exists, contact Dowco immediately)
- Please note that Sill flashings, mounting clips are optional. Fasteners are supplied by the installer.

These are the instructions on how to properly install your louver/s. Depending on the actual field condition and manpower, the following are just minimum recommendations only. The installer shall be responsible to fully comply in accordance with the project specifications and the approved shop drawings and shall be responsible for adding the structural supports if necessary. The installer shall be responsible to caulk the louvers "watertight" before installing them.

RECEIVING/INSPECTION

Upon receiving your louver shipment, inspect the crates carefully. If there is visible damage, contact the freight company immediately so a freight claim can be filed if necessary. Caution should be used when removing the louvers from the crates. Once uncrated, the louvers should be checked for proper size, finish, frame style, screen actuator and overall appearance. Any discrepancies should be reported to **DOWCO** immediately.

STORAGE

Store in an orderly manner at a safe location away from construction traffic, material, etc. to prevent damage. Cover with plastic sheeting to protect from excessive moisture, dirt and debris.

PRE-ASSEMBLY

1. Remove the louver from the shipping container and inspect for damage. Care must be taken handling a louver. Lift by the frame or brace and not by the blade. Do not drop, drag, step on or apply excessive force on louver.
2. Inspect opening where louvers are to be installed. Opening should be $\frac{1}{4}$ " larger or more than louver dimensions plus any expansion spacing required. If installing adjustable louvers, check the linkage thoroughly and test if blades will open and close. If problems occur do not install them and call **DOWCO** immediately. Normally, pre-testing is conducted prior to shipping.

MULTIPLE SECTION ASSEMBLY

1. Position louver sections together. Align and match frame markings or labels on adjacent sections as indicated in the shop drawings.
2. On multiple section assemblies with visible mullions, install the louver section within the t-mullion, align and match frame markings or labels on adjacent sections. Normally t-mullions are factory mounted to front and back of each sections.
3. Align t-mullions on adjacent frames. Fasten together with self-tapping screws sp. approx. @ 18" o.c. (Note: Field installation where self-tapping screws are required not supplied by Dowco)
4. On multiple section assemblies with invisible mullions, remove all factory-mounted side plates held with screws, align blades from the exterior side and match frame markings or labels on adjacent sections, fasten the two angles together with $\frac{1}{4}$ "-20 x 1" lg. HH bolts & nuts leaving $\frac{1}{8}$ " or more for expansion joint.
5. On multiple stackable section assemblies with concealed mullions in height due to paint size limitation or shipping, splice plates are factory mounted to the outer side of louver jamb or angle brace, fasten together with self-tapping screws.
6. Use appropriate shims between louver frames and opening structure to prevent distortion of louver frame.
7. Individual sections of multiple assemblies, as well as the entire assembly, must be square and free from racking. Measure diagonally from upper corners to opposite lower corners of each section. Both dimensions must equal $\frac{1}{8}$ inch + or -.
8. Multiple section louver assemblies may require structural bracing to support the weight of the assembly and specified wind loads.

RECOMMENDED INSTALLATION OF LOUVERS

1. Louvers must be plumb and square, and install within the opening using clips angles or approved equal positioned @ every 18" or 24" on center. Mounting clips must be without pilot holes.
2. Clip angles with self-drilling screws (2 per clip) and extended sills are available as options. Use #10-16 x 1" lg. HWH for self-tapping screws. Wall trim, caulk, and any other fasteners are by others.

STEP 1. PREPARATION

MEASURE THE SHORTEST DISTANCE. IF THE ORDERED SIZE IS GREATER THAN THE LOUVER SIZE. CALL FACTORY IMMEDIATELY.

1. LOCATE ALL PURCHASED ITEMS AND ORGANIZE ACCORDING TO PACKAGE LIST OR SCHEDULE.
2. CONFIRM THAT ALL PRODUCTS ARE PRESENT.
3. INSPECT OPENINGS; REPAIR ANY DAMAGES THAT MAY PROHIBIT THE LOUVER FROM BEING INSERTED.
4. BE SURE OPENING IS PLUMB AND IS CONSISTENT WITH THE SIZE OF THE LOUVER.

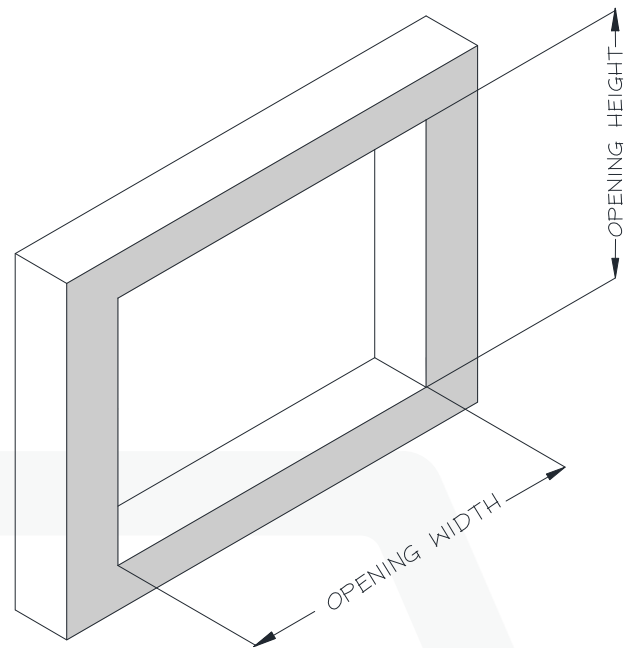

STEP 2. SILL FLASHING OR SILL PAN INSTALLATION (IF REQUIRED)

1. APPLY CAULK ONTO SILL OPENING AND INSTALL SILL FLASHING BY PRESSING DOWN FIRMLY.
2. IF MULTIPLE SILL FLASHINGS ARE REQUIRED, LEAVE $\frac{1}{4}$ " SPACE IN BETWEEN SILLS.
3. APPLY CAULK ON THE EDGES OF SILLS PER DETAIL "A"
4. PRESS SPLICE PLATE FIRMLY ON TOP OF SILLS THEN SECURE WITH SCREWS.

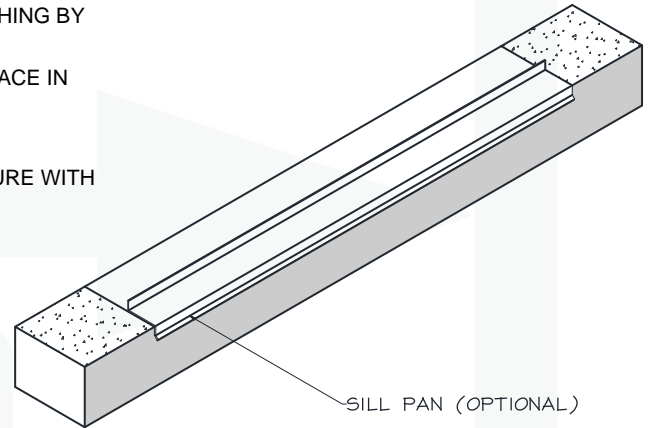
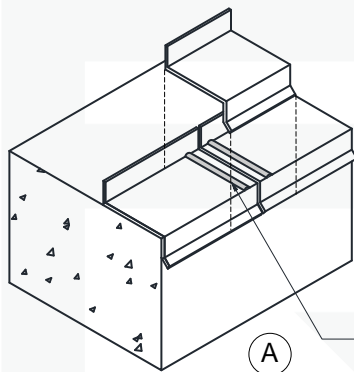

STEP 3. MOUNTING CLIP ANGLES

1. REFER TO SHOP DRAWINGS FROM SIZE AND DETAILS OF MOUNTING CLIP ANGLES.
2. MEASURE THE DISTANCE OF MOUNTING CLIP ANGLE ACCORDING TO THE REQUIRED SETBACK FROM THE FACE OF THE WALL.
3. DRILL HOLES INTO WALL TO FIT FOR ANCHORS AT SPACING PER APPROVED SHOP DRAWINGS OR AT EVERY 18" OC. USE MIN. #10 SCREWS.

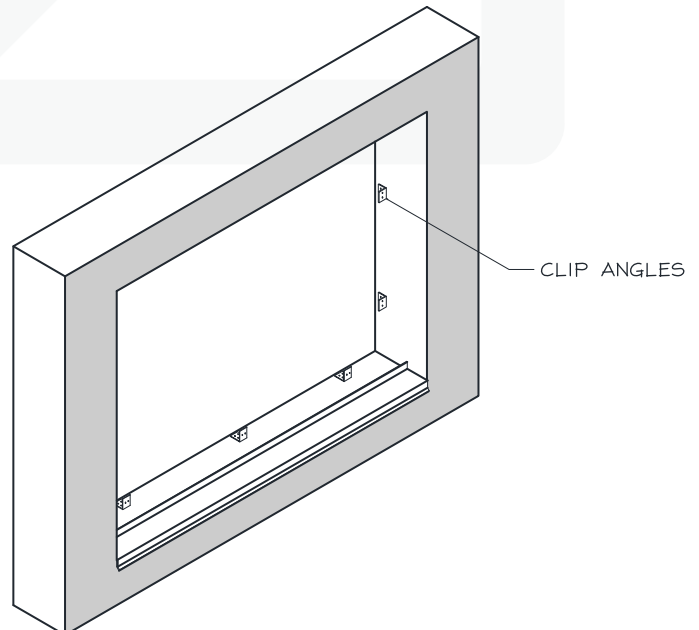

STEP 4.

INSTALLING SINGLE LOUVER

1. PLACE LOUVER SECTION INTO OPENING.
2. CHECK EDGES OF PERIMETER TO MEET PROPER CLEARANCE PER APPROVED DRAWINGS. SHIM AROUND LOUVER WHERE NECESSARY.
3. MAKE SURE THE LOUVER IS PLUMB AND ONCE THE PROPER PLACEMENT IS ACHIEVED, SECURE THE LOUVER USING THE MOUNTING CLIP AT JAMB, HEAD AND SILL. USE CLIP ANGLES AS A GUIDE TO DRILL HOLES INTO JAMBS.
4. USE FASTENERS MINIMUM OF #10-16 x 1" FROM MOUNTING CLIPS TO LOUVER FRAME (2 PER CLIP)
5. IF INSTALLING SINGLE LOUVER PROCEED TO STEP 7.



STEP 5a.

INSTALLING INVISIBLE MULLIONS

1. POSITION LOUVER SECTIONS TOGETHER. ALIGN AND MATCH FRAME MARKINGS OR LABELS ON ADJACENT SECTIONS AS INDICATED IN THE SHOP DRAWINGS.
2. REMOVE ALL FACTORY-MOUNTED SIDE PLATES HELD WITH SCREWS.
3. START FROM ONE SIDE FAR LEFT OF THE OPENING ONE COLUMN AT THE TIME.
4. FOR INVISIBLE VERTICAL – FASTEN THE TWO ANGLES TOGETHER WITH MIN. #12-16 X 1-1/2" SELF-DRILLING @ 18" OC. LEAVING 1/8" OR MORE FOR EXPANSION JOINT.
5. FOR INVISIBLE HORIZONTAL – ALIGN JAMBS TOGETHER USING THE FACTORY INSTALLED SPLICE PLATES OR ANGLE BRACE, FASTEN TOGETHER WITH MIN.# 12-16 X 1-1/2 SELF-DRILLING SCREWS.

SHOWN FROM BEHIND



INVISIBLE HORIZONTAL



INVISIBLE VERTICAL

STEP 5b.

INSTALLING VISIBLE MULLIONS

1. POSITION LOUVER SECTIONS TOGETHER. ALIGN AND MATCH FRAME MARKINGS OR LABELS ON ADJACENT SECTIONS AS INDICATED IN THE SHOP DRAWINGS.
2. START FROM ONE SIDE FAR LEFT OF THE OPENING ONE COLUMN AT THE TIME. NORMALLY T-MULLIONS ARE FACTORY INSTALLED TO FRONT AND BACK OF EACH SECTION.
3. FOR VISIBLE VERTICAL - FASTEN THE SECTIONS TOGETHER THROUGH T-MULLION WITH MIN.# 10-16 X 1 SELF-DRILLING SCREW @ 18" OC.
4. FOR VISIBLE HORIZONTAL - INSTALL THE BOTTOM SECTION IN PLACE FIRST THEN CAULK THE HEAD TO RECEIVE THE T-MULLION OF THE UPPER SECTION, FASTEN TOGETHER WITH MIN. # 10-16 X 1 SELF-DRILLING SCREW @ 18" OC.



VISIBLE HORIZONTAL

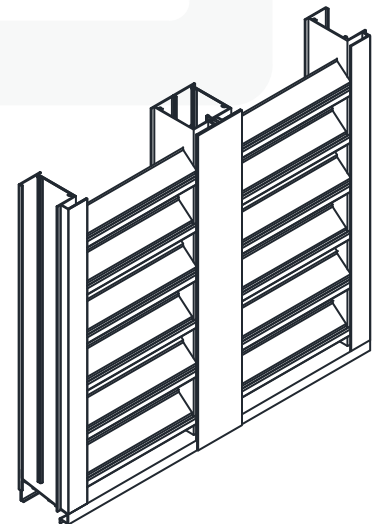

VISIBLE VERTICAL

STEP 6. SILL SPLICE COVER

1. LOCATE SILL FRAMES WITH INVISIBLE MULLION.
2. APPLY A LAYER OF CAULK LEFT AND RIGHT BENEATH THE SPLICE COVER
3. FASTEN THE SPLICE COVER TO SILL FRAMES TO HOLD IN PLACE.



STEP 7. CAULKING

1. AFTER THE LOUVER SECTIONS ARE IN PLACE AND SECURED, MAKE SURE THE LOUVERS ARE PLUMB.
2. PLACE A BACKER ROD AND CAULK ALL AROUND THE PERIMETER OF THE LOUVER WITH THE SAME COLOR AS THE LOUVERS



SEE APPLIED CAULK SECTION DETAIL "B"

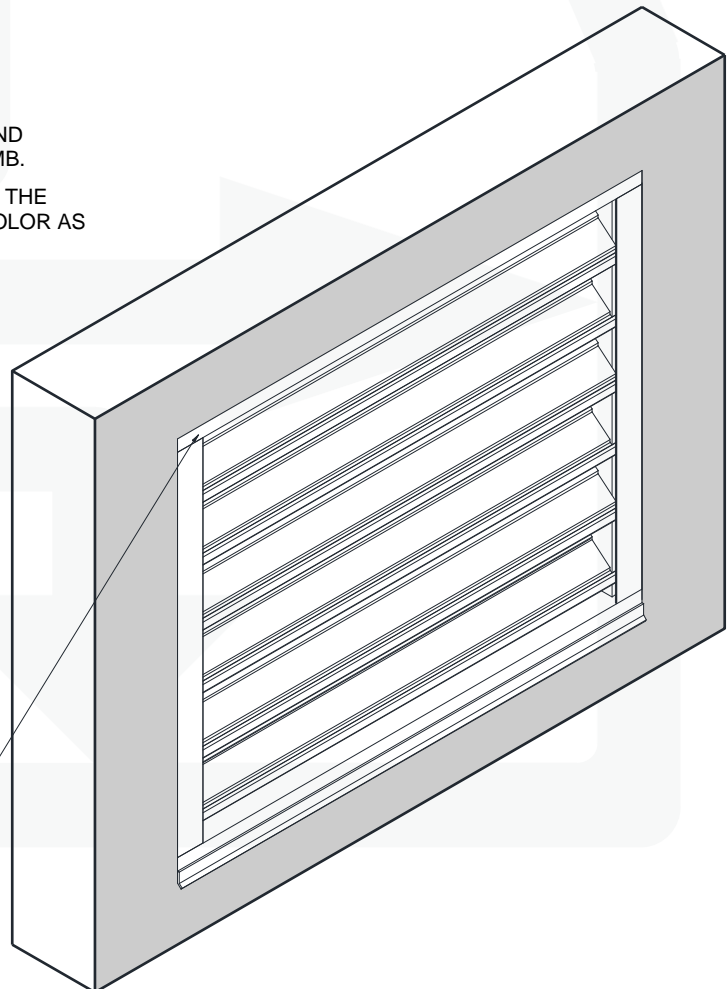

Please call your Sales Representative if you have further questions or problems.

DOWCO
Products Group
A division of Safe Air of Illinois