

STANDARD CONSTRUCTION

OPTIONAL CONSTRUCTION

STATIONARY EXTRUDED ALUMINUM LOUVER

LEZ-02/SERIES

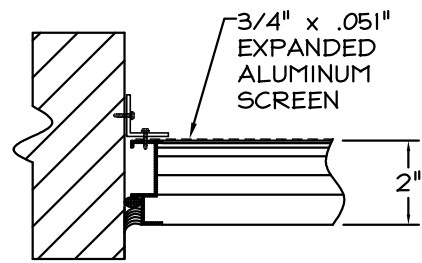

(EXTERIOR)
BOX FRAME

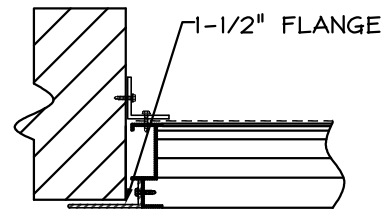

(EXTERIOR)
FLANGE FRAME

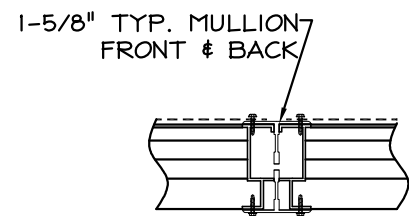

(EXTERIOR)
VERTICAL VISIBLE MULLION

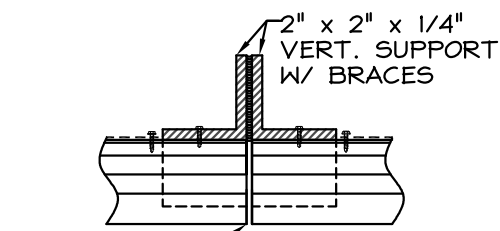

(EXTERIOR)
VERTICAL INVISIBLE MULLION

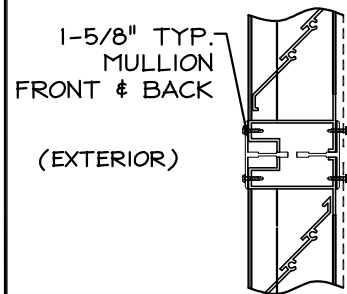

(EXTERIOR)
HORIZONTAL VISIBLE MULLION

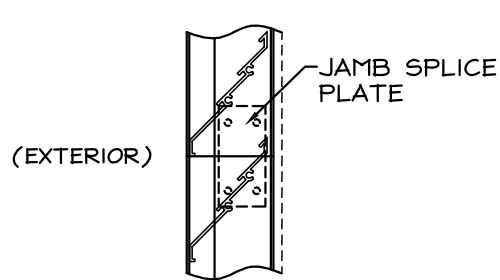

(EXTERIOR)
HORIZONTAL INVISIBLE MULLION

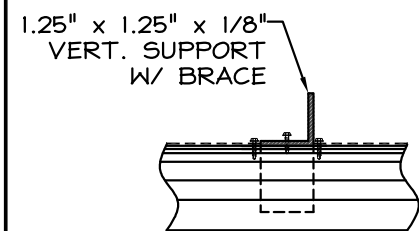

(EXTERIOR)
CONTINUOUS BLADE

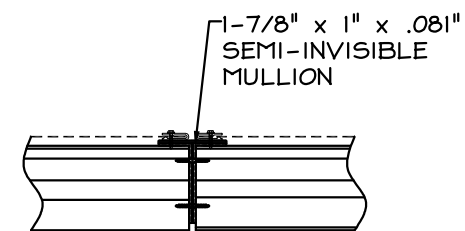

(EXTERIOR)
SEMI-INVISIBLE MULLION

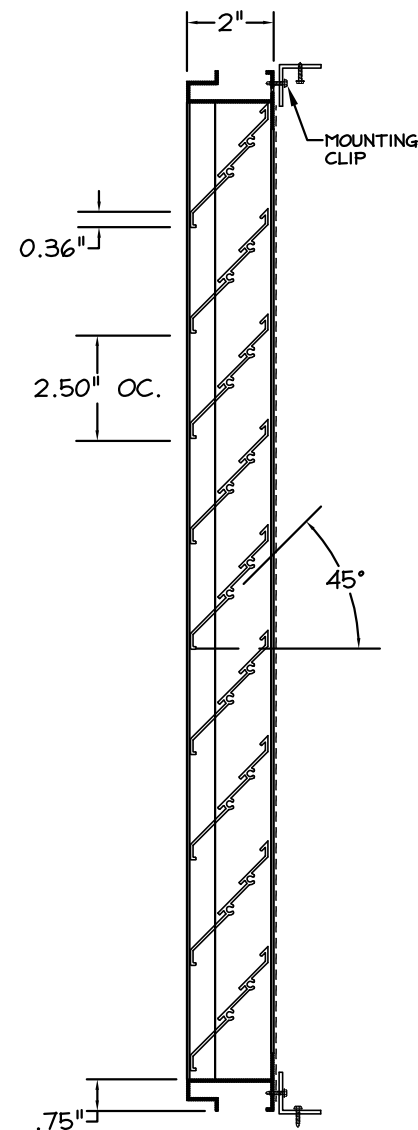

VERTICAL SECTION

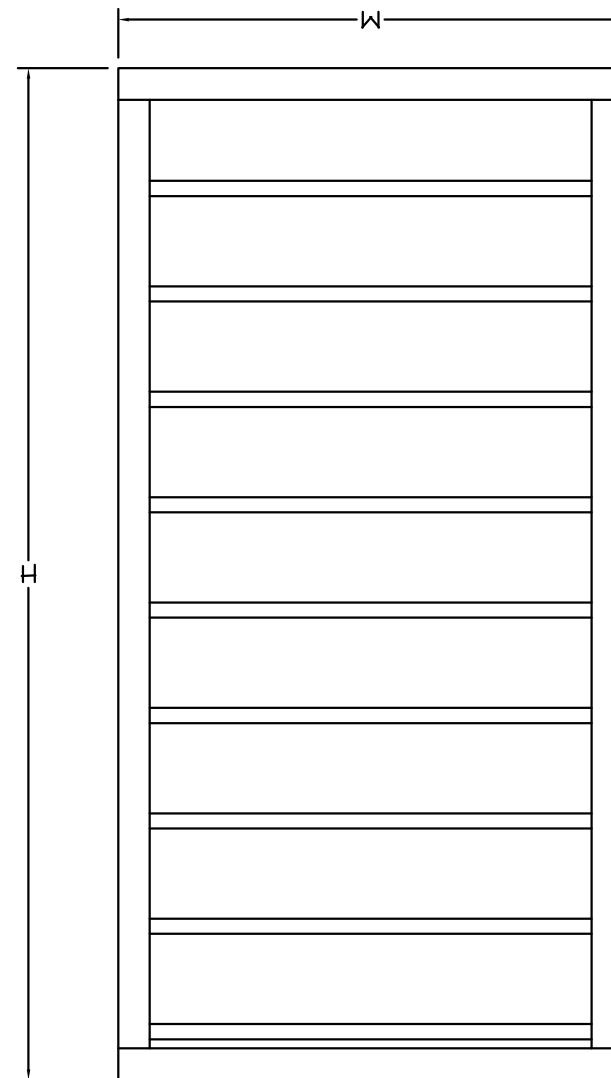

FRONT ELEVATION

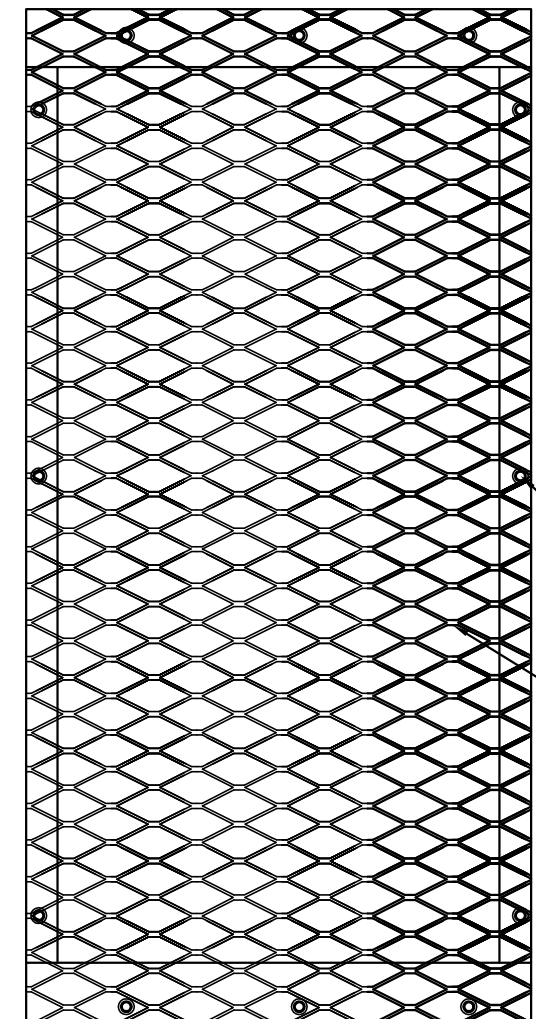

BACK ELEVATION

#10-16 X 1" PLTD. STL. TEK SCREW
3/4" X .051" EXPANDED ALUMINUM SCREEN NO FRAME

REV.	DESCRIPTION	DATE	BY

STANDARD CONSTRUCTION:
 FRAME: .063" THK. EXTRUDED ALUM. 6063-T5
 BLADES: .063" THK. EXTRUDED ALUM. 6063-T5
 FASTENERS: #10-16 X 1" PLTD. STL. TEK SCREW
 SCREEN: 3/4" X .051" EXPANDED ALUMINUM SCREEN NO FRAME
 FINISH: MILL

NOTES:
 1. ALL LOUVERS TO BE FABRICATED 1/4" UNDER LISTED OPENING SIZES UNLESS SPECIFIED "ACTUAL"
 2. ALL OPENING SIZES TO BE FIELD VERIFIED AND GUARANTEED BY OTHERS PRIOR TO FABRICATION.
 3. OTHER SURROUNDING FINISHES ARE FOR REFERENCES ONLY AND TO BE SUPPLIED BY OTHERS.

LOUVER SCHEDULE

TAG	QTY	SIZE (WXH)	NOTES



DEPENDABLE PRODUCTS SINCE 1955

1855 SOUTH 54TH AVENUE, CICERO, IL. 60650

ARCH/ENGR: _____ CUSTOMER: _____

PROJECT: _____ TITLE: LEZ-02/SERIES

DATE: _____ DRAWN: _____

SCALE: 1:1 CHKD: _____ DRWG #: _____