

Combination Fixed / Adjustable Drainable Blade Louver Model C-DWE-46

Design Features – Traditional straight architectural design with blades fixed at 45° angle. Louver construction conforms with SMACNA and ASHRAE standards.

STANDARD CONSTRUCTION

ALL MATERIAL – EXTRUDED ALUMINUM 6063-T5 (KB-45)

FRAME

6" (152) Deep, .081" (2.1) extruded aluminum in style #3

BLADES

Fixed – Drainable .081" (2.1) extruded aluminum @ 5-1/2" (140) OC. 45°

Adjustable - .125" thk. extruded aluminum

BLADE AXLES & BEARINGS

Axles – 7/16" (11) plated steel hex

Bearings – 1/2" (13) dia. bronze oilite

LINKAGE

Plated steel concealed in jamb

BLADE & JAMB SEALS

Vinyl blade and flexible metal jamb seals

MAXIMUM SIZE

Unlimited, with mullions, structural bracing supplied by others

MAXIMUM SINGLE SECTION

60" W x 96"H (1524 X 2438) (Type of finish may limit maximum single section)

MULLION

Visible

MINIMUM SIZE

12"w x 12"h (305 X 305)

UNDERSIZED

1/4" (6) under ordered size unless specified Exact or Actual

SCREEN

3/4" x .051" (19 X 1.3) flattened expanded aluminum bird screen in frame

FINISH

Mill

OPERATOR

Standard Manual Operator

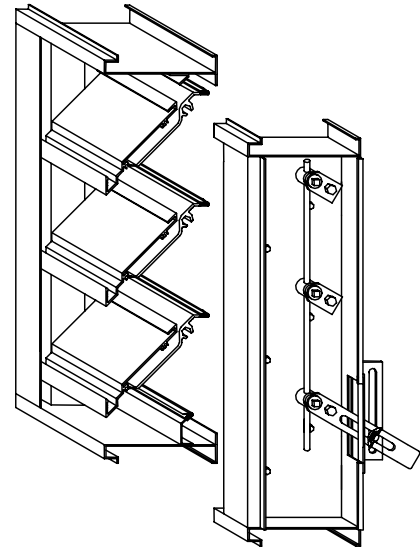

MULLION STYLE

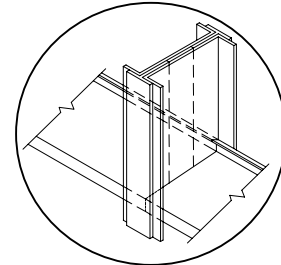

Visible

OPTIONAL CONSTRUCTION

FRAME – Available in a heavier extrusion of .125" (3.2)

BLADES - Available in a heavier extrusion of .125" (3.2)

BLADES & JAMB SEALS – Vinyl blade edge and / or flexible metal jamb seals

SCREEN - Many styles available please consult screen listing

LINKAGE – Blade mounted

FINISH – Air-dry primer, polyurethane, epoxy, or enamel, baked epoxy or enamel, Kynar, or Powder coat.

OPERATOR – Wingnut, Electric, or Pneumatic

SPECIAL PURPOSE CONSTRUCTION

Security bars

Filter racks

Sleeved for ductwork connection

Jackshaft when required

** Consult Safe-Air Dowco for additional technical information

TYPICAL SCREEN STYLES



Expanded Aluminum Standard

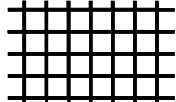

Wire Mesh

FRAME STYLES

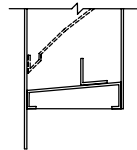

(1) - Flange 1-1/2"

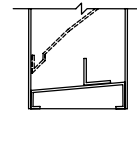

(3) - Box Standard

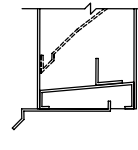

(8) - Box and Sill Extension

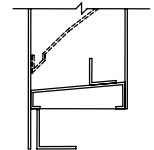

(9) - Flange w/ sub frame

DATE		ARCHITECT		CUSTOMER	
PROJECT					
ITEM	QTY	W	H	<p>DOWCO PRODUCTS GROUP certifies that the CDWE-46 louver shown herein is licensed to bear the AMCA Seal. The ratings shown are based on tests and procedures performed in accordance with AMCA Publication 511 and comply with the requirements of the AMCA Certified Ratings Program. The AMCA Certified Ratings Seal applies to air performance ratings and water penetration ratings.</p>	



DEPENDABLE PRODUCTS SINCE 1955

SAFE-AIR OF ILLINOIS INC.

Engineering and General Offices

1855 South 54th Avenue, Cicero, Illinois 60804

Phone 708-652-9100 FAX 708-652-9158

All tests performed at an independent laboratory and based on AMCA standard 511 – 91 for air performance and water penetration.

AIR PERFORMANCE

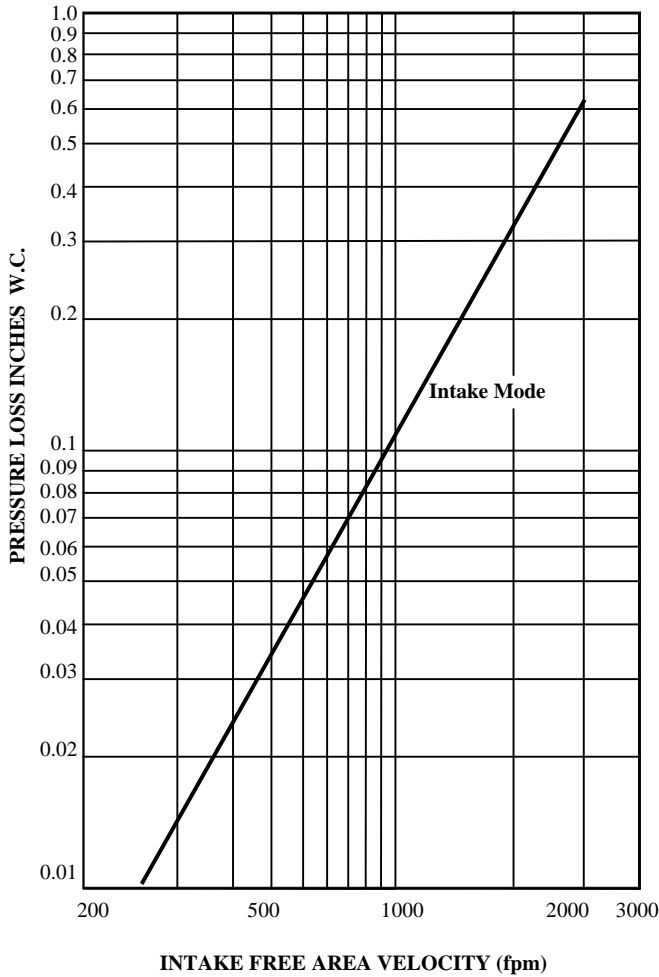

CALCULATING PRESSURE LOSS

Based upon a given flow rate (in CFM), the flowing pressure loss may be determined from the “air performance” graph, knowing the sq. ft. of free area of the louver. Alternately, the free area may be determined based upon a volumetric flow rate and a maximum pressure loss. Utilizing the “air performance” graph.

_____ in. W.C. Max. Pressure Loss Intake or Exhaust
 _____ FPM (Free Area Velocity From “Air Performance” Graph)
 _____ CFM / _____ FPM Free Area Velocity = _____ Sq. Ft. Free Area

CALCULATING MAXIMUM AIRFLOW BEFORE WATER PENETRATION

The “free area flow rate” at which water penetration commences (.01 oz. of water) is established at, 929 fpm (283) for C-DWE-46, and will vary depending upon actual weather conditions. The “water penetration” graph illustrates the results of actual laboratory test on a 48” x 48” (1219 x 1219) test sample subjected to hypothetical rainfall conditions. To determine the free area (in sq. ft.) based upon a known volumetric flow rate in CFM;

_____ CFM / _____ FPM = _____ SQ. FT. FREE AREA
 (System Requirements)

Water Penetration Graph
 in oz. of water per sq. ft. of free area over a 15 min. test period

	.01	.02	.05	.1	.2	.3 (H2O)
	929	967	1017	1055	1093	1115 (fpm)

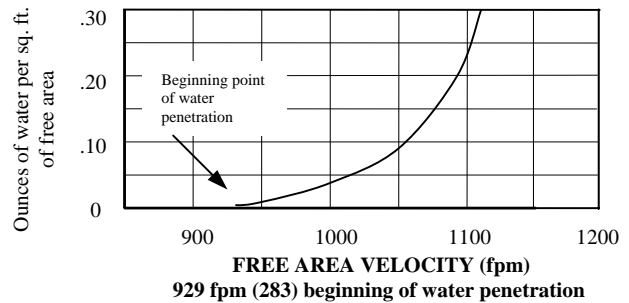

FREE AREA CALCULATIONS IN SQ. FT.

WIDTH

HEIGHT	WIDTH									
	Inches	12	18	24	30	36	42	48	54	60
12		0.19	0.33	0.47	0.61	0.74	0.88	1.02	1.16	1.29
18		0.41	0.70	0.99	1.28	1.57	1.86	2.15	2.45	2.74
24		0.63	1.07	1.52	1.96	2.40	2.85	3.29	3.73	4.18
30		0.85	1.44	2.04	2.64	3.23	3.83	4.43	5.02	5.62
36		1.06	1.81	2.56	3.31	4.06	4.81	5.56	6.31	7.06
42		1.28	2.18	3.09	3.99	4.89	5.79	6.70	7.60	8.50
48		1.50	2.55	3.61	4.66	5.72	6.78	7.83	8.89	9.95
54		1.71	2.92	4.13	5.34	6.55	7.76	8.97	10.18	11.39
60		1.93	3.29	4.65	6.02	7.38	8.74	10.10	11.47	12.83
66		2.15	3.66	5.18	6.69	8.21	9.72	11.24	12.76	14.27
72		2.36	4.03	5.70	7.37	9.04	10.71	12.38	14.04	15.71
78		2.58	4.40	6.22	8.05	9.87	11.69	13.51	15.33	17.15
84		2.80	4.77	6.75	8.72	10.70	12.67	14.65	16.62	18.60
90		3.01	5.14	7.27	9.40	11.53	13.65	15.78	17.91	20.04
96		3.23	5.51	7.79	10.07	12.36	14.64	16.92	19.20	21.48