

## Drainable / Sightproof Louver in 6" thick frame design Model DEM-06

**Design Features** – Drainable blade vision proof design.

### STANDARD CONSTRUCTION

ALL MATERIAL – EXTRUDED ALUMINUM 6063-T5 (KB-45)

#### FRAME

6" thick, is .081 extruded aluminum in style #3.

#### BLADES

.081" (2.1) extruded aluminum, apx. spacing is 2-1/4" @ 30°

#### MAXIMUM SIZE

Unlimited, with mullions, structural bracing supplied by others

#### MAXIMUM FACTORY ASSEMBLY SIZE

120" w x 96 H" or 96" w x 120" H

(allows for best handling)

(Type of finish may limit maximum single section)

#### MULLION

Invisible

#### MINIMUM SIZE

12" w x 12" H

#### UNDERSIZED

1/4" under ordered size unless specified Exact or Actual

#### SCREEN

3/4" x .051" flattened expanded aluminum bird screen no frame

#### FINISH

Mill

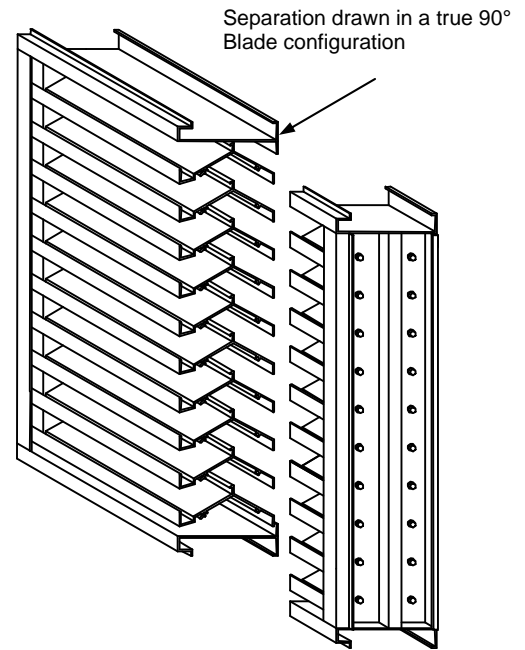

### OPTIONAL CONSTRUCTION

**FRAME** – Available in a heavier extrusion of .125"

**BLADES** – Available in a heavier extrusion of .125"

**SCREEN** - Many styles available please consult screen listing

**FINISH** – Air-dry primer, polyurethane, epoxy, or enamel. Baked epoxy, Anodize or Kynar

**MULLION** – Visible for architectural preference

### MULLION STYLES

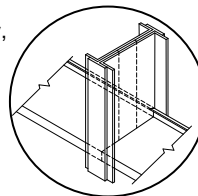

Visible

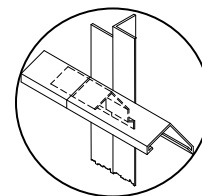

Invisible

PERFORMANCE
Point of water penetration
1121 fpm
Free area
48 x 48 section
57%

### SPECIAL PURPOSE CONSTRUCTION

Fully welded construction

Security bars

Filter racks

Hinged as walk through door or for swing out access

Sleeved for ductwork connection

### TYPICAL SCREEN STYLES

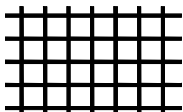

Wire Mesh



Expanded Aluminum Standard

### FRAME STYLES

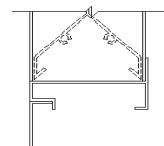

1 - Flange (1.5")

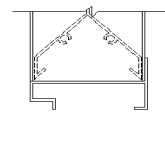

3 - Box

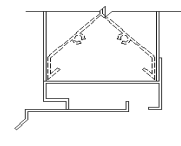

8 - Box with Sill Extension

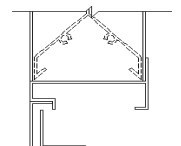

9 - Flange with Sub Frame

DATE	ARCHITECT			CUSTOMER
PROJECT				
ITEM	QTY	W	H	



DEPENDABLE PRODUCTS SINCE 1955

**SAFE-AIR OF ILLINOIS INC.**

*Engineering and General Offices*

1855 South 54<sup>th</sup> Avenue, Cicero, Illinois 60804

Phone 708-652-9100 FAX 708-652-9158

All tests performed at an independent laboratory and based on AMCA standard 511 – 91 for air performance and water penetration.

### AIR PERFORMANCE

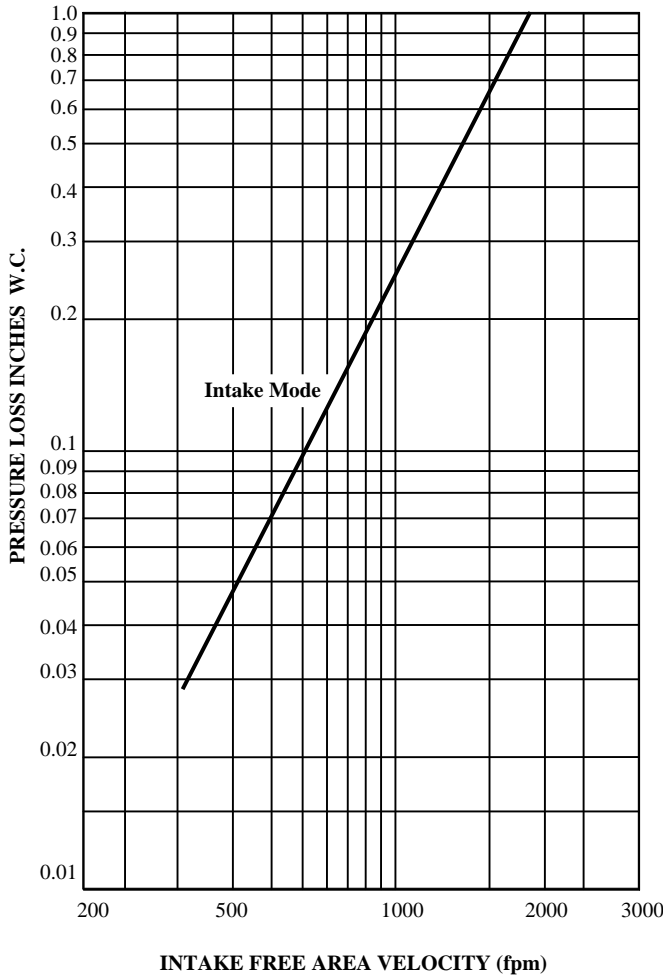

### CALCULATING PRESSURE LOSS

Based upon a given flow rate (in CFM), the flowing pressure loss may be determined from the “air performance” graph, knowing the sq. ft. of free area of the louver. Alternately, the free area may be determined based upon a volumetric flow rate and a maximum pressure loss. Utilizing the “air performance” graph.

\_\_\_\_\_ in. W.C. Max. Pressure Loss Intake or Exhaust  
 \_\_\_\_\_ FPM (Free Area Velocity From “Air Performance” Graph)  
 \_\_\_\_\_ CFM / \_\_\_\_\_ FPM Free Area Velocity = \_\_\_\_\_ Sq. Ft. Free Area

### CALCULATING MAXIMUM AIRFLOW BEFORE WATER PENETRATION

The “free area flow rate” at which water penetration commences (.01 oz. of water) is established at 1121 fpm for DEM-06, and will vary depending upon actual weather conditions. The “water penetration” graph illustrates the results of actual laboratory test on a 48” x 48” test sample subjected to hypothetical rainfall conditions. To determine the free area (in sq. ft.) based on upon a known volumetric flow rate in CFM;

\_\_\_\_\_ CFM / \_\_\_\_\_ FPM = \_\_\_\_\_ SQ. FT. FREE AREA  
 (System Requirements)

Water Penetration Graph  
 in oz. of water per sq. ft. of  
 free area over a 15 min. test period

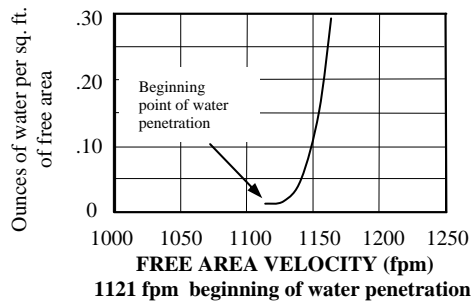

### FREE AREA CALCULATIONS IN SQ. FT.

#### WIDTH

INCHES	12	18	24	30	36	42	48	54	60	66	72	78	84	90	96	102	108	114	120
12	.36	.58	.79	1.01	1.22	1.44	1.66	1.87	2.09	2.31	2.52	2.74	2.95	3.17	3.39	3.60	3.82	4.04	4.25
18	.63	1.01	1.39	1.77	2.14	2.52	2.90	3.28	3.66	4.04	4.41	4.79	5.17	5.55	5.93	6.30	6.68	7.06	7.44
24	.90	1.44	1.98	2.52	3.06	3.60	4.14	4.68	5.22	5.76	6.30	6.85	7.39	7.93	8.47	9.01	9.55	10.09	10.63
30	1.17	1.87	2.58	3.28	3.98	4.68	5.39	6.09	6.79	7.49	8.20	8.90	9.60	10.30	11.01	11.71	12.41	13.11	13.82
36	1.44	2.31	3.17	4.04	4.90	5.76	6.63	7.49	8.36	9.22	10.09	10.95	11.82	12.68	13.55	14.41	15.28	16.14	17.01
42	1.71	2.74	3.76	4.79	5.82	6.85	7.87	8.90	9.93	10.95	11.98	13.01	14.03	15.06	16.09	17.11	18.14	19.17	20.19
48	1.98	3.17	4.36	5.55	6.74	7.93	9.12	10.30	11.49	12.68	13.87	15.06	16.25	17.44	18.63	19.82	21.00	22.19	23.38
54	2.25	3.60	4.95	6.30	7.66	9.01	10.36	11.71	13.06	14.41	15.76	17.11	18.46	19.82	21.17	22.52	23.87	25.22	26.57
60	2.52	4.04	5.55	7.06	8.57	10.09	11.60	13.11	14.63	16.14	17.65	19.17	20.68	22.19	23.71	25.22	26.73	28.25	29.76
66	2.79	4.47	6.14	7.82	9.49	11.17	12.84	14.52	16.19	17.87	19.55	21.22	22.90	24.57	26.25	27.92	29.60	31.27	32.95
72	3.06	4.90	6.74	8.57	10.41	12.25	14.09	15.92	17.76	19.60	21.44	23.27	25.11	26.95	28.79	30.62	32.46	34.30	36.14
78	3.33	5.33	7.33	9.33	11.33	13.33	15.33	17.33	19.33	21.33	23.33	25.33	27.33	29.33	31.33	33.33	35.33	37.32	39.32
84	3.60	5.76	7.93	10.09	12.25	14.41	16.57	18.73	20.90	23.06	25.22	27.38	29.54	31.70	33.87	36.03	38.19	40.35	42.51
90	3.87	6.20	8.52	10.84	13.17	15.49	17.82	20.14	22.46	24.76	27.11	29.43	31.76	34.08	36.41	38.73	41.05	43.38	45.70
96	4.14	6.63	9.12	11.60	14.09	16.57	19.06	21.54	24.03	26.52	29.00	31.49	33.97	36.46	38.95	41.43	43.92	46.40	48.89

HEIGHT

