

Weather Protective Blade Louver in 4" deep frame design • Model LEB-04

Design Features – Traditional design with upper blade surface turn back for improved weather protection and architectural pleasing appearance. Louvers are designed to withstand inward and outward wind pressure up to 25 psf (100 mph).

STANDARD CONSTRUCTION

ALL MATERIAL – EXTRUDED ALUMINUM 6063-T5 (KB-45)

FRAME

LEB-04, 4" (102) deep, .081 ga. (2.1) extruded alum. in style #3.

BLADES

LEB-04, 4" (102), .081" ga. (2.1) extruded alum, approx. spacing is 5" (127) @ 45°

FASTENERS

#10 Plated steel screw

MAXIMUM SIZE

Unlimited, with mullions, structural bracing supplied by others

MAXIMUM FACTORY ASSEMBLY SIZE

120" W x 96" H (3048 x 2438) or vice versa (allows for best handling) (Type of finish may limit maximum single section)

MULLION

Invisible

MINIMUM SIZE

12" W x 12" H (305 x 305)

UNDERSIZED

1/4" (6) under ordered size unless specified Exact or Actual

SCREEN

3/4" x .051" ga. (19 x 1.3) flattened expanded alum. bird screen no frame

FINISH

Mill

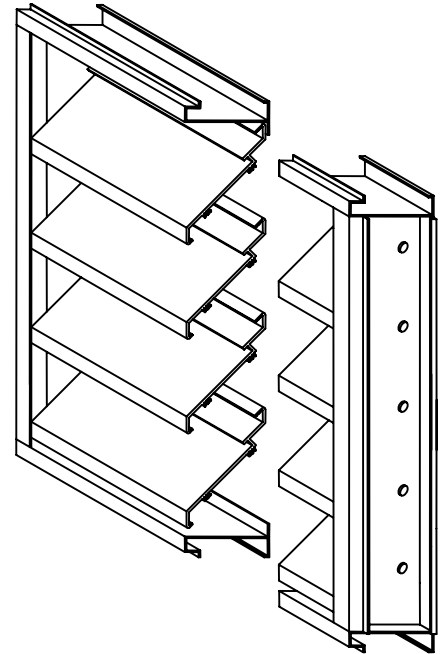

OPTIONAL CONSTRUCTION

FRAME – Available in a heavier extrusion of .125" ga. (3.2)

BLADES – Available in a heavier extrusion of .125" ga. (3.2)

SCREEN - Many styles available please consult screen listing

FINISH – Air-dry primer, Polyurethane, Epoxy, Baked Enamel, Powder Coat, Anodized or Kynar 500.

MULLION – Visible for architectural preference

SPECIAL PURPOSE CONSTRUCTION

Special Shapes; Round, Triangle, Trapezoid, Octagon, and etc.

Fully welded construction

Security bars

Filter racks

Hinged as walk through door or for swing out access

Sleeved for ductwork connection

MULLION STYLES

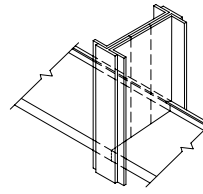

Visible

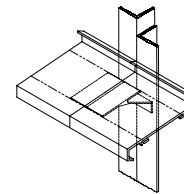

Invisible Standard

PERFORMANCE

Point of Water Penetration
930 fpm (284)

Free Area
48" x 48" (1219 x 1219)
47%

TYPICAL SCREEN STYLES

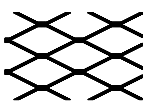

Expanded Aluminum Standard

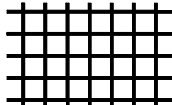

Wire Mesh

FRAME STYLES

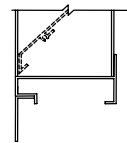

(1) - Flange 1-1/2" (38)

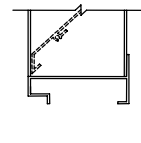

(3) - Box Standard

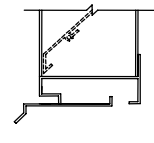

(8) - Box and Sill Extension

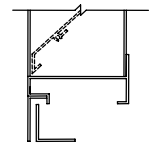

(9) - Flange w/ sub frame

DATE		ARCHITECT / ENGINEER			CUSTOMER	
PROJECT						
ITEM	QTY	W	H	TAG	<p>AMCA CERTIFIED RATINGS</p> <p>WATER PENETRATION AIR PERFORMANCE</p> <p>AIR MOVEMENT AND CONTROL ASSOCIATION, INC.</p> <p>MEMBER OF THE UNITED STATES OF AMERICA</p>	<p>DOWCO PRODUCTS GROUP certifies that the LEB-04 louver shown herein is licensed to bear the AMCA Seal. The rating shown is based on tests and procedures performed in accordance with AMCA Publication 511 and comply with the requirements on the AMCA Certified Ratings Program. The AMCA Certified Ratings Seal applies to air performance ratings and water penetration ratings.</p>



DEPENDABLE PRODUCTS SINCE 1955

SAFE-AIR / DOWCO

Engineering and General Offices

1855 South 54th Avenue / Cicero, Illinois 60804

Phone: 708-652-9100 FAX: 708-652-9158

All tests performed at an independent laboratory and based on AMCA standard 511 – 91 for air performance and water penetration.

AIR PERFORMANCE

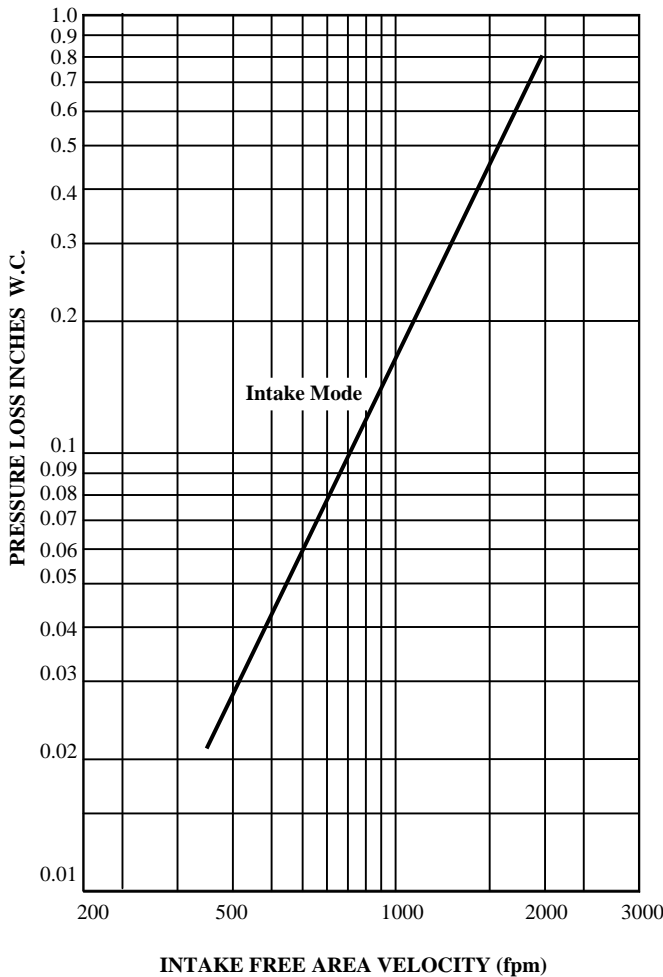

CALCULATING PRESSURE LOSS

Based upon a given flow rate (in CFM), the flowing pressure loss may be determined from the “air performance” graph, knowing the sq. ft. of free area of the louver. Alternately, the free area may be determined based upon a volumetric flow rate and a maximum pressure loss. Utilizing the “air performance” graph.

_____ in. W.C. Max. Pressure Loss Intake or Exhaust
 _____ FPM (Free Area Velocity From “Air Performance” Graph)
 _____ CFM / _____ FPM Free Area Velocity = _____ Sq. Ft. Free Area

CALCULATING MAXIMUM AIRFLOW BEFORE WATER PENETRATION

The “free area flow rate” at which water penetration commences (.01 oz. of water) is established at, 930 fpm (284) for LEB-04, and will vary depending upon actual weather conditions. The “water penetration” graph illustrates the results of actual laboratory test on a 48” x 48” (1219 x 1219) test sample subjected to hypothetical rainfall conditions. To determine the free area (in sq. ft.) based on upon a known volumetric flow rate in CFM;

_____ CFM / _____ FPM = _____ SQ. FT. FREE AREA
 (System Requirements)

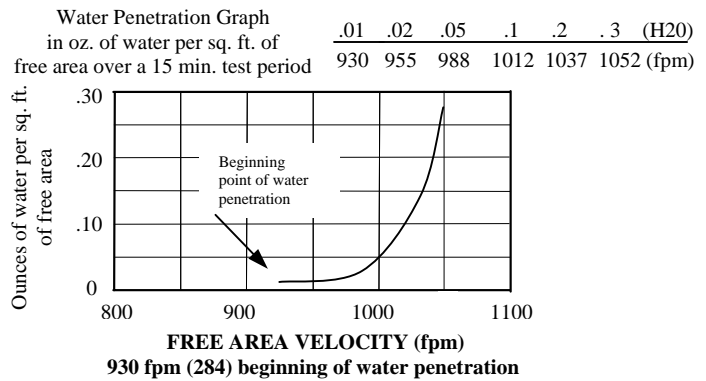

FREE AREA CALCULATIONS IN SQ. FT.

WIDTH

INCHES	12	18	24	30	36	42	48	54	60	66	72	78	84	90	96	102	108	114	120
12	.24	.39	.53	.68	.83	.97	1.12	1.26	1.41	1.56	1.70	1.85	1.99	2.14	2.28	2.43	2.58	2.72	2.87
18	.43	.68	.94	1.19	1.45	1.70	1.96	2.21	2.47	2.72	2.98	3.23	3.49	3.74	4.00	4.25	4.51	4.76	5.02
24	.69	1.11	1.53	1.94	2.36	2.78	3.19	3.61	4.03	4.44	4.86	5.28	5.69	6.11	6.53	6.94	7.36	7.78	8.19
30	.94	1.50	2.06	2.63	3.19	3.75	4.31	4.88	5.44	6.00	6.56	7.13	7.69	8.25	8.81	9.38	9.94	10.50	11.06
36	1.11	1.78	2.44	3.11	3.78	4.44	5.11	5.78	6.44	7.11	7.78	8.44	9.11	9.78	10.44	11.11	11.78	12.44	13.11
42	1.35	2.17	2.98	3.79	4.60	5.42	6.23	7.04	7.85	8.67	9.48	10.29	11.10	11.92	12.73	13.54	14.35	15.17	15.98
48	1.62	2.60	3.57	4.55	5.52	6.49	7.47	8.44	9.41	10.39	11.36	12.34	13.31	14.28	15.26	16.23	17.21	18.18	19.15
54	1.81	2.89	3.97	5.06	6.14	7.22	8.31	9.39	10.47	11.56	12.64	13.72	14.81	15.89	16.97	18.06	19.14	20.22	21.31
60	2.01	3.22	4.43	5.64	6.85	8.06	9.26	10.47	11.68	12.89	14.10	15.31	16.51	17.72	18.93	20.14	21.35	22.56	23.76
66	2.28	3.65	5.02	6.39	7.76	9.13	10.50	11.87	13.24	14.61	15.98	17.35	18.72	20.09	21.46	22.83	24.20	25.57	26.94
72	2.50	4.00	5.50	7.00	8.50	10.00	11.50	13.00	14.50	16.00	17.50	19.00	20.50	22.00	23.50	25.00	26.50	28.00	29.50
78	2.67	4.28	5.88	7.49	9.09	10.69	12.30	13.90	15.51	17.11	18.72	20.32	21.92	23.53	25.13	26.74	28.34	29.94	31.55
84	2.94	4.71	6.47	8.24	10.01	11.77	13.54	15.30	17.07	18.83	20.60	22.36	24.13	25.90	27.66	29.43	31.19	32.96	34.72
90	3.19	5.11	7.03	8.94	10.86	12.78	14.69	16.61	18.53	20.44	22.36	24.28	26.19	28.11	30.03	31.94	33.86	35.78	37.69
96	3.37	5.39	7.41	9.43	11.45	13.47	15.49	17.51	19.53	21.56	23.58	25.60	27.62	29.64	31.66	33.68	35.70	37.72	39.74

HEIGHT