

EXTRUDED ALUMINUM LOUVER

Weather Protective Blade Louver in 4" thick frame design Model LEC-04

Design Features – Traditional straight architectural design with blades fixed at a 45° angle.

STANDARD CONSTRUCTION

ALL MATERIAL – EXTRUDED ALUMINUM 6063-T5 (KB-45)

FRAME

LEC – 04" (102) thick, is .081 (2.1) extruded aluminum in style #3.

BLADES

LEC – 04" (102) are .081" (2.1) extruded aluminum, apx. spacing is 4 1/2" (114) @ 45°

MAXIMUM SIZE

Unlimited, with mullions, structural bracing supplied by others

MAXIMUM FACTORY ASSEMBLY SIZE

120" w x 96 H" or 96" w x 120" H (3048 x 2438) or (2438 x 3048)
(allows for best handling)
(Type of finish may limit maximum single section)

MULLION

Visible

MINIMUM SIZE

12" w x 12" H (305 x 305)

UNDERSIZED

1/4" (6) under ordered size unless specified Exact or Actual

SCREEN

3/4" .051" (19 x 1.3) flattened expanded aluminum bird screen no frame

FINISH

Mill

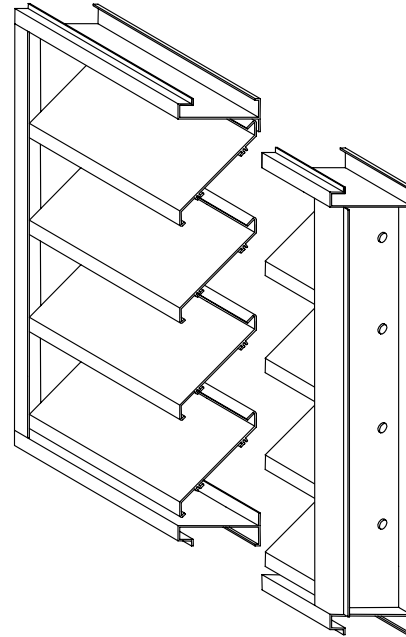

PERFORMANCE

Point of
water penetration
879 fpm (268)

Free area
48 x 48 section
50%

OPTIONAL CONSTRUCTION

FRAME – Available in a heavier extrusion of .125" (3.2)

BLADES – Available in a heavier extrusion of .125" (3.2)

SCREEN - Many styles available please consult screen listing

FINISH – Air-dry primer, polyurethane, epoxy, or enamel. Baked epoxy, Anodize or Kynar

MULLION – Visible for architectural preference

SPECIAL PURPOSE CONSTRUCTION

Special Shapes; Round, Triangle, Trapezoid, Octagon, etc.

Fully welded construction

Security bars

Filter racks

Hinged as walk through door or for swing out access

Sleeved for ductwork connection

MULLION STYLES

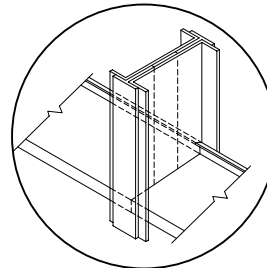

Visible (Standard)

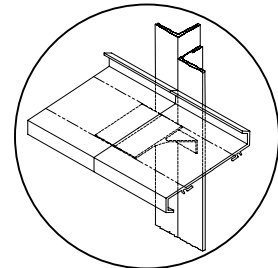

Invisible

FRAME STYLE

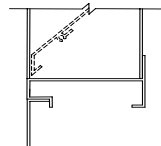

1- Flange (1.5")

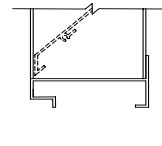

3 - Box

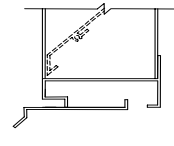

8- Box with
Sill Extension

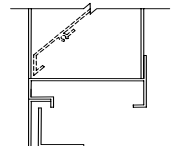

9 - Flange
with Sub Frame

TYPICAL SCREEN STYLES

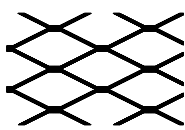

Expanded Aluminum
Standard

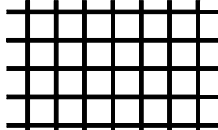

Wire Mesh

DATE	ARCHITECT			CUSTOMER	
PROJECT					
ITEM	QTY	W	H		SAFE-AIR/DOWCO certifies that the LEC-04 louver shown herein is licensed to bear the AMCA Seal. The ratings shown are based on tests and procedures performed in accordance with AMCA Publication 511 and comply with the requirements of the AMCA Certified Ratings Program. The AMCA Certified Ratings Seal applies to air performance ratings and water penetration ratings.

LEC-04 PERFORMANCE SPECIFICATIONS

All tests performed at an independent laboratory and based on AMCA standard 511 – 91 for air performance and water penetration.

AIR PERFORMANCE

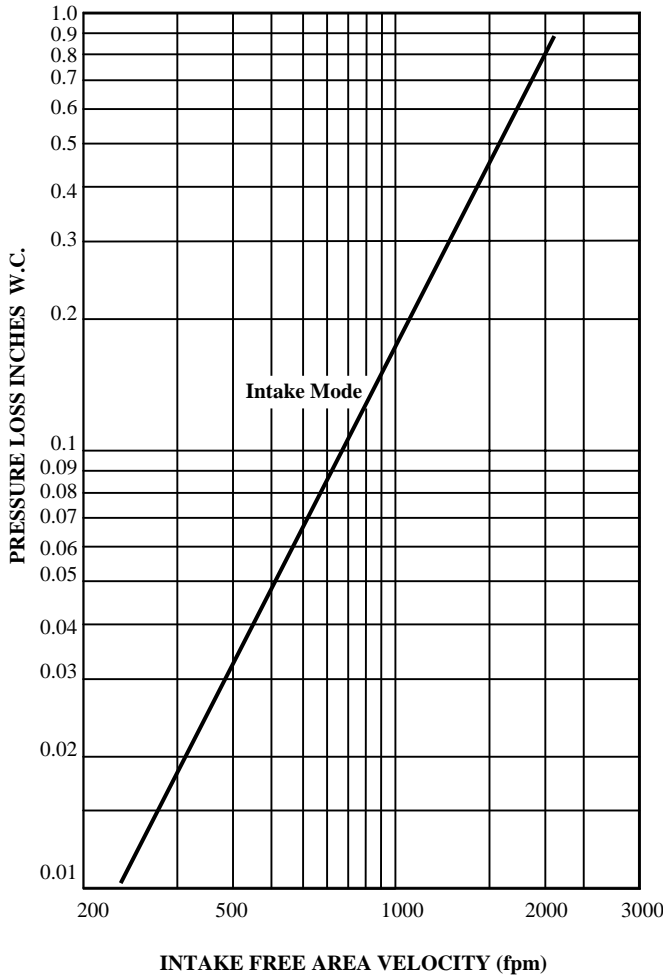

CALCULATING PRESSURE LOSS

Based upon a given flow rate (in CFM), the flowing pressure loss may be determined from the “air performance” graph, knowing the sq. ft. of free area of the louver. Alternately, the free area may be determined based upon a volumetric flow rate and a maximum pressure loss. Utilizing the “air performance” graph.

_____ in. W.C. Max. Pressure Loss Intake or Exhaust
 _____ FPM (Free Area Velocity From “Air Performance” Graph)
 _____ CFM / _____ FPM Free Area Velocity = _____ Sq. Ft. Free Area

CALCULATING MAXIMUM AIRFLOW BEFORE WATER PENETRATION

The “free area flow rate” at which water penetration commences (.01 oz. of water) is established at, 879 fpm (268) for LEC-04, and will vary depending upon actual weather conditions. The “water penetration” graph illustrates the results of actual laboratory test on a 48” x 48” (1219 x 1219) test sample subjected to hypothetical rainfall conditions. To determine the free area (in sq. ft.) based on upon a known volumetric flow rate in CFM;

_____ CFM / _____ FPM = _____ SQ. FT. FREE AREA
 (System Requirements)

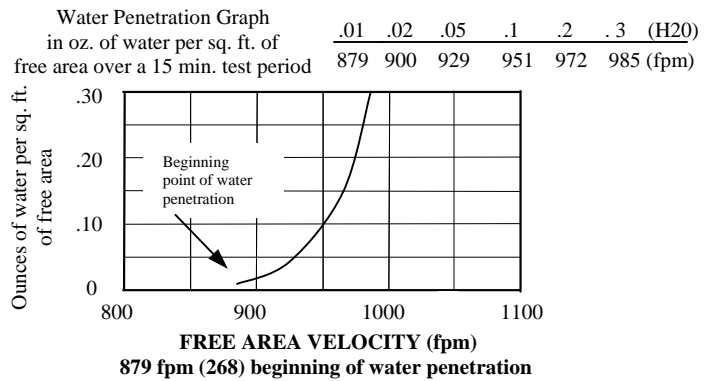

FREE AREA CALCULATIONS IN SQ. FT.

WIDTH

INCHES	12	18	24	30	36	42	48	54	60	66	72	78	84	90	96	102	108	114	120
12	.28	.44	.61	.77	.94	1.10	1.27	1.43	1.60	1.76	1.93	2.10	2.26	2.43	2.59	2.76	2.92	3.09	3.25
18	.54	.87	1.19	1.52	1.84	2.17	2.49	2.82	3.15	3.47	3.80	4.12	4.45	4.77	5.10	5.42	5.75	6.07	6.40
24	.72	1.16	1.59	2.02	2.46	2.89	3.33	3.76	4.19	4.63	5.06	5.50	5.93	6.36	6.80	7.23	7.66	8.10	8.53
30	1.00	1.60	2.20	2.80	3.40	4.00	4.59	5.19	5.79	6.39	6.99	7.59	8.19	8.79	9.39	9.99	10.59	11.19	11.79
36	1.27	2.02	2.78	3.54	4.30	5.06	5.82	6.58	7.34	8.10	8.86	9.62	10.38	11.13	11.89	12.65	13.41	14.17	14.93
42	1.45	2.31	3.18	4.05	4.92	5.78	6.65	7.52	8.39	9.25	10.12	10.99	11.86	12.73	13.59	14.46	15.33	16.20	17.06
48	1.72	2.75	3.79	4.82	5.85	6.89	7.92	8.95	9.99	11.02	12.05	13.09	14.12	15.15	16.19	17.22	18.25	19.28	20.32
54	1.99	3.18	4.37	5.57	6.76	7.95	9.15	10.34	11.53	12.73	13.92	15.11	16.30	17.50	18.69	19.88	21.08	22.27	23.46
60	2.17	3.47	4.77	6.07	7.38	8.68	9.98	11.28	12.58	13.88	15.18	16.49	17.79	19.09	20.39	21.69	22.99	24.29	25.60
66	2.44	3.91	5.38	6.85	8.31	9.78	11.25	12.71	14.18	15.65	17.11	18.58	20.05	21.52	22.98	24.45	25.92	27.38	28.85
72	2.71	4.34	5.97	7.59	9.22	10.85	12.47	14.10	15.73	17.35	18.98	20.61	22.23	23.86	25.49	27.11	28.74	30.37	31.99
78	2.89	4.63	6.36	8.10	9.83	11.57	13.30	15.04	16.77	18.51	20.25	21.98	23.72	25.45	27.19	28.92	30.66	32.39	34.13
84	3.17	5.07	6.97	8.87	10.77	12.67	14.57	16.47	18.37	20.27	22.18	24.08	25.98	27.88	29.78	31.68	33.58	35.48	37.38
90	3.43	5.50	7.56	9.62	11.68	13.74	15.80	17.86	19.92	21.98	24.04	26.10	28.16	30.22	32.28	34.34	36.41	38.47	40.53
96	3.62	5.78	7.95	10.12	12.29	14.46	16.63	18.80	20.97	23.14	25.31	27.48	29.64	31.81	33.98	36.15	38.32	40.49	42.66

HEIGHT